

LED CCT Panel 200 (Bi-Color)

LAMPHEAD CONTENTS

- Lamp Housing
- Diffuser
- Stirrup with Ø28mm (1-1/8 in.) Spigot
- Power Supply
- Power Supply Holder
- AC Power Cable
- DC Power Cable



LED CCT Panel 200 (Bi-Color)

SPECIFICATIONS

Identity No.	L002BSCP
Max. Capacity	200W
Voltage	48V DC
Current	4.2A @ 48V
Color Temp.	Adjustable 2700K - 6000K
CRI	>95
TLCI	>95
Dimming Range	0-100%
Control Signal	DMX 512
DMX Channel	2
LED Life	Approx. 30,000 Hrs
M.O. Stirrup	Ø28mm (1-1/8 in.) Spigot
Class / IP Rating	1 / IP 20
Max. Surface Temp.	60 °C
Max. Ambient Temp.	45 °C
Min. Distance to Illuminated Object	1 m
Min. Distance to Flammable Object	0.5 m
Operating Range	+90° - 0° - -90°
Weight	6.0 kg

ACCESSORIES

Soft Box

Eggcrate

4-leaf Barndoor

P.O. Stirrup with Ø28mm (1-1/8 in.) Spigot

Safety Cable (for lamphead)

Back



Power Supply & Holder

Power Supply



Power Supply Holder

POWER SUPPLY

Input Voltage	100 - 240V AC
Output Voltage	48V DC
Frequency	50Hz / 60Hz
Class / IP Rating	1 / IP 20
Weight	1.5 kg

■ PHOTOMETRIC DATA

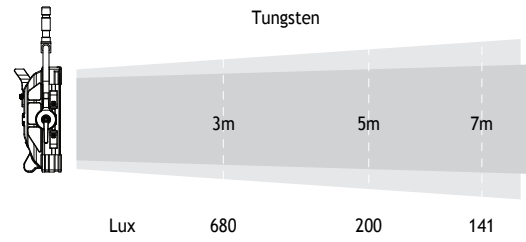
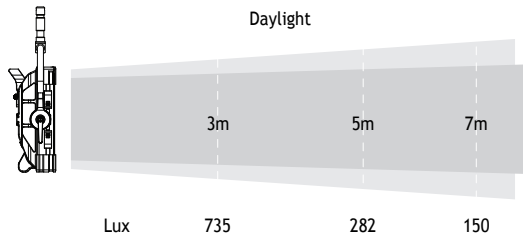

■ SPECTRUM

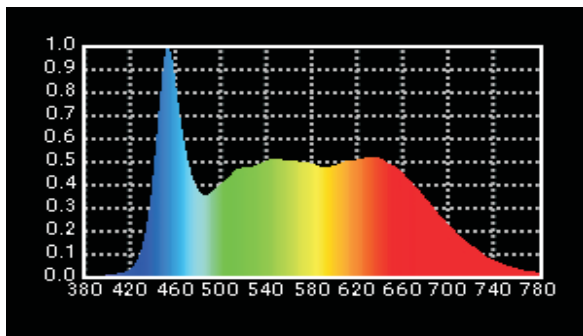

Daylight

■ HISTOGRAM

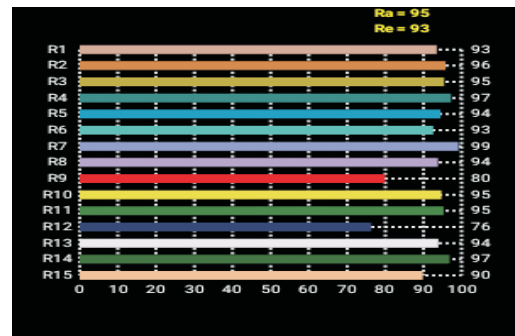

Daylight

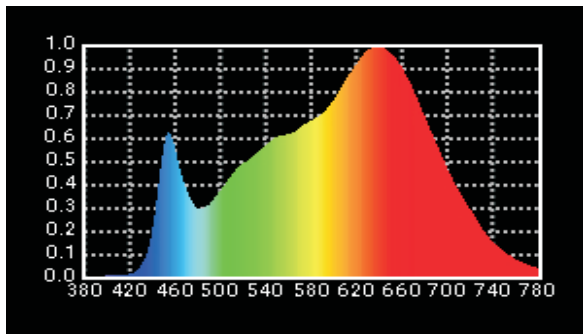

Tungsten

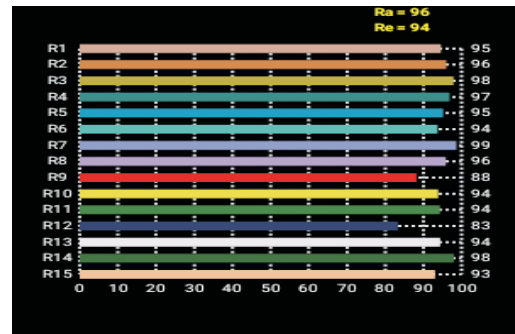

Tungsten

■ DIMENSIONS (mm)

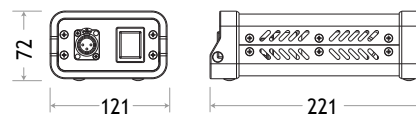
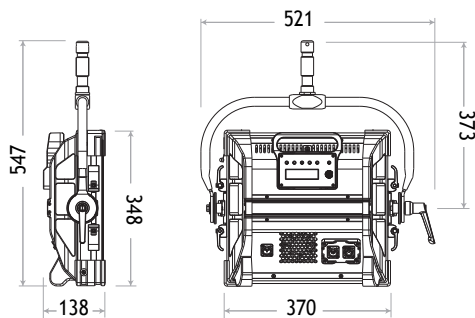

Power Supply