



## Daylight Boxer 800W

### LAMPHEAD CONTENTS

- Lamp Housing without Bulb #
- 4-leaf Rotatable Barndoor with Safety Wire
- Set of 5 Par Lenses with Lens Case
- Inlet Cable with Multi-Pin Connector
- Stirrup with Ø16mm (5/8 in.) Socket
- Glass Beaker
- Reflector

# Requires Electronic Ballast, Lamphead to Ballast Cable and Lamp Bulb

## Daylight Boxer 800W

### SPECIFICATIONS

Identity No.	L00800BX
Capacity	800W
Lamp Bulb Voltage	9.3A / 95V AC
Par Lens	Ø175mm (6-7/8 in.)
Lamp Type	HMI 800W SE
Color Temp.	5600K
Lamp Holder	G22
Stirrup	Ø16mm (5/8 in.) Socket
Class / IP Rating	1 / IP 20
Max. Surface Temp.	170 °C
Max. Ambient Temp.	45 °C
Min. Distance to Illuminated Object	6 m
Min. Distance to Flammable Object	0.5 m
Operating Range	+45° ~ 0° ~ -45°
Weight (Lamphead)	2.5 kg

### ACCESSORIES

Electronic Ballast V3 : 800W/575W or 800W/575W AC/DC

Lamphead to Ballast Cable : 7m (23 ft.) or 15m (49 ft.)

DC Y-Cable

4-leaf Rotatable Barndoor

Set of 5 Par Lenses Ø175mm (6-7/8 in.) with Lens Case

Spot, Medium Flood, Wide Flood,

Super Wide Flood, Frosted Super Flood

Safety Cable (for lamphead)

Safety Wire (for barndoor)

T-Ring

Softbox

Lantern

Barrel Adapter

Barrel

### PHOTOMETRIC DATA

		6m	9m	12m
800W	Spot (8°)	Lux 58748	26110	14687
	Beam Ø	0.84 m	1.26 m	1.68 m
Medium Flood (10° x 20°)	Lux	8838	3928	2209
	Beam Ø	1.05 x 2.12 m	1.57 x 3.17 m	2.10 x 4.23 m
Wide Flood (20° x 45°)	Lux	5081	2258	1270
	Beam Ø	2.16 x 4.97 m	3.17 x 7.46 m	4.23 x 9.94 m
Super Wide Flood (40°)	Lux	1843	819	461
	Beam Ø	4.37 m	6.55 m	8.74 m
Frosted Super Flood (37°)	Lux	1089	484	272
	Beam Ø	4.02 m	6.02 m	8.03 m

### DIMENSIONS (mm)

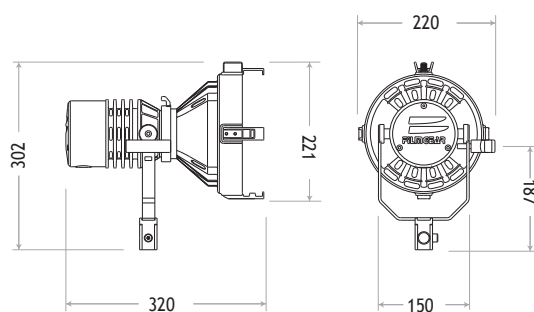

Daylight Boxer with Reflector

■ ACCESSORY CONFIGURATION

**Daylight Boxer with Reflector**



Reflector



**Daylight Boxer with Softbox**



T-ring

+



Softbox



**Daylight Boxer with Lantern**



T-ring

+



Lantern



**Daylight Boxer with Barrel**

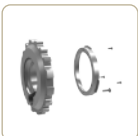

Barrel Adapter

+



Barrel

